

# Build the robot!

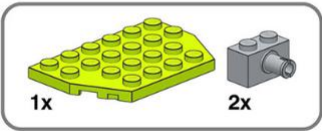

**Pteranodon**





**1**

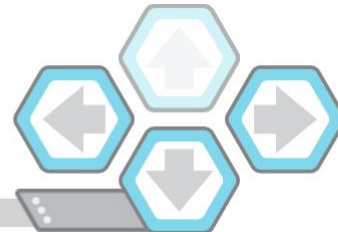
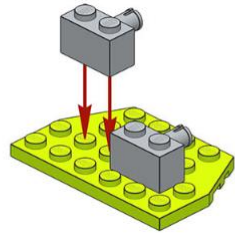

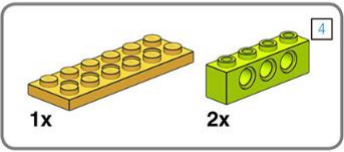

**2**

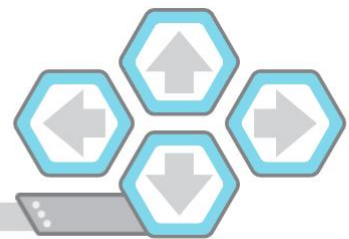
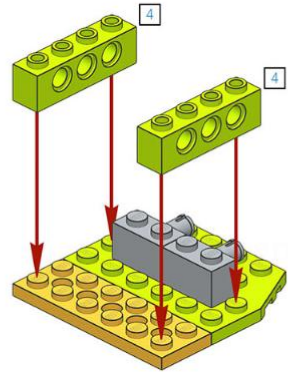

# Construction steps

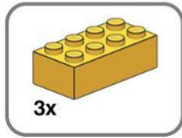

**3**

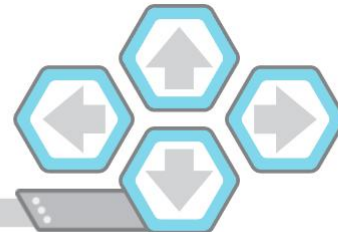
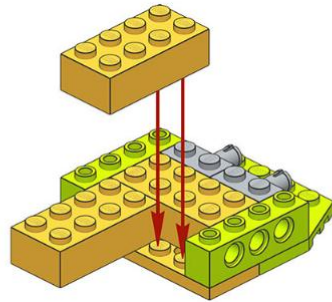

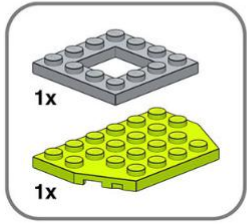

**4**

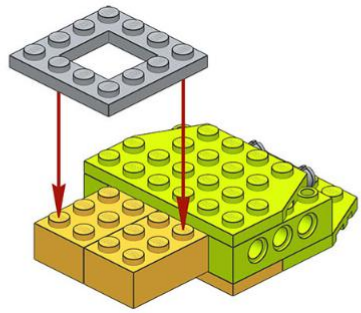

antirrobotisch.de

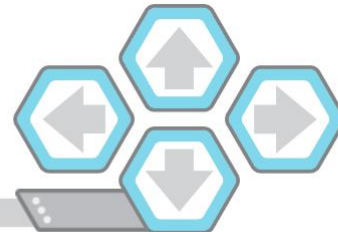

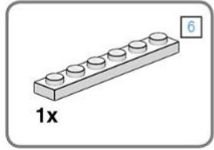

**5**

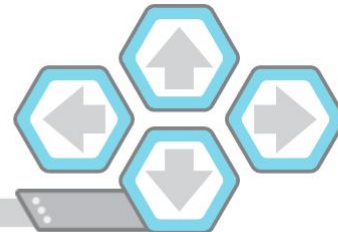
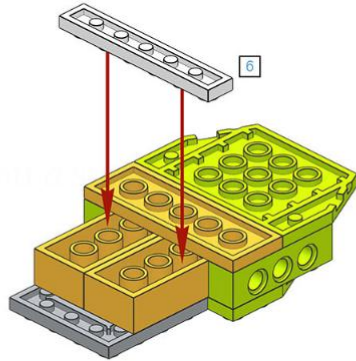

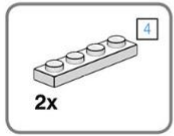

**6**

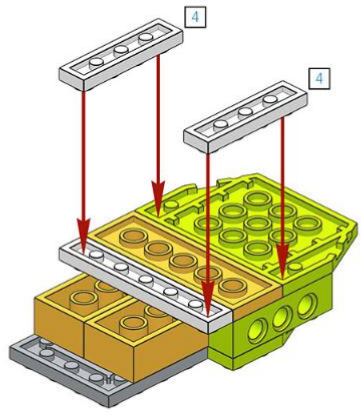

www.winn-school.it

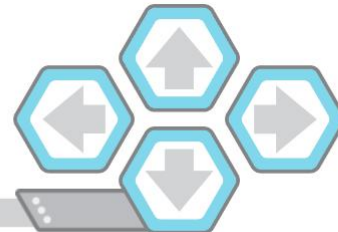

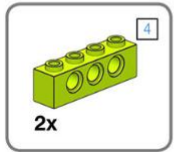

**7**

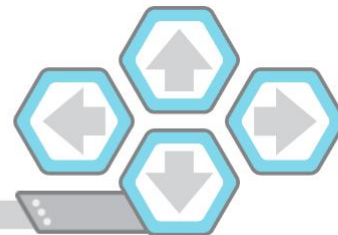
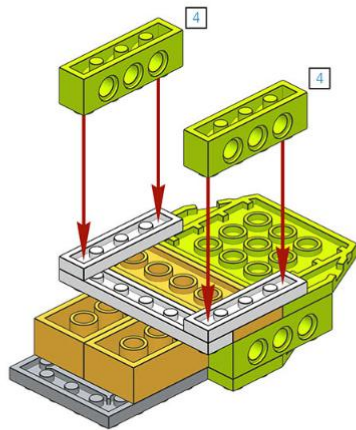



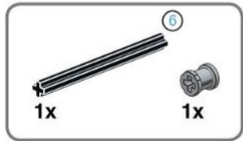

**8**

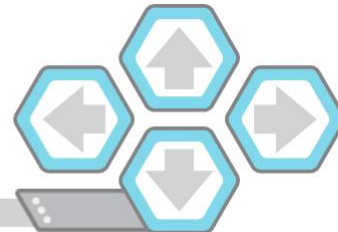
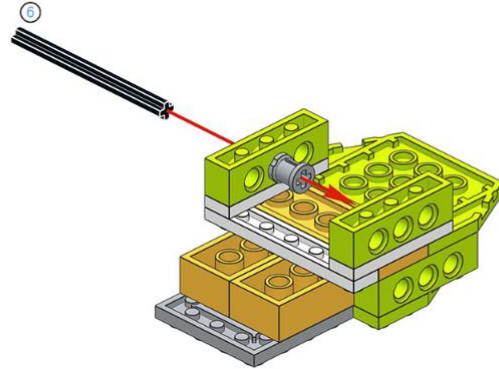

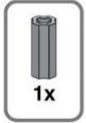

**9**

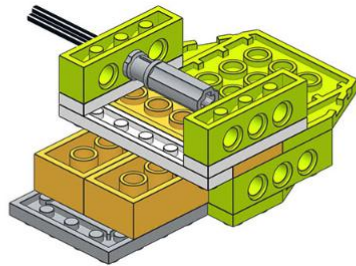

~>001-part-clied<~

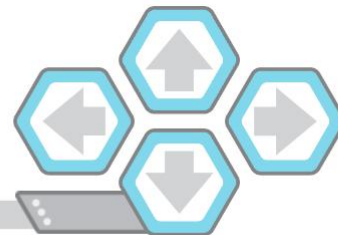



**10**

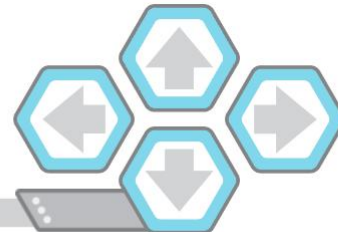
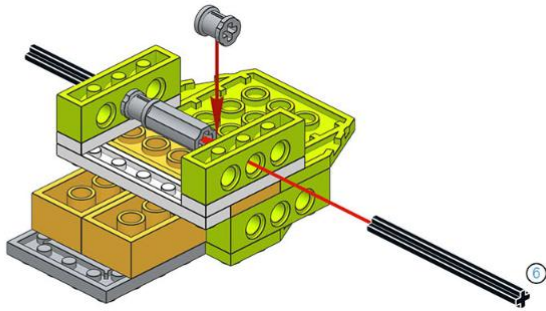

# 11

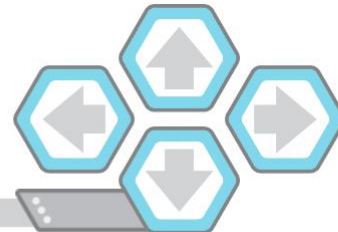
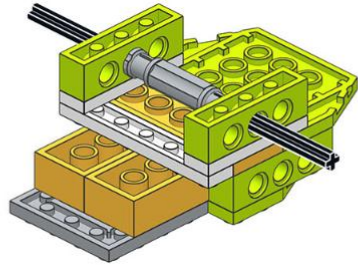

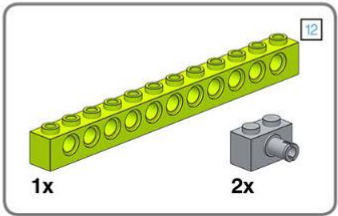
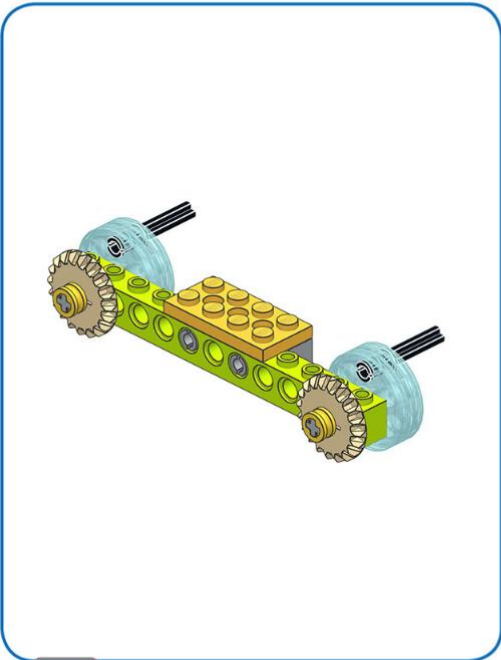

**12**

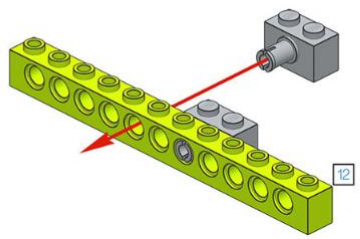

smartwortschool.es

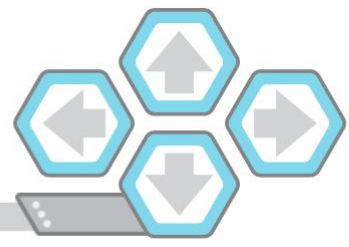

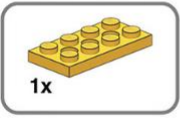

**13**

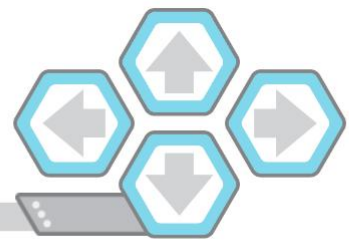
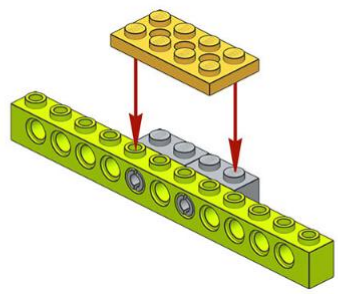

**1**

2x  
1x

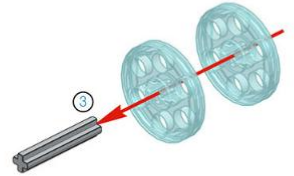

**2**

1x



**3**

2x

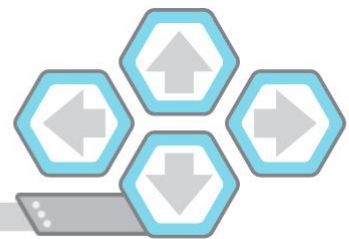
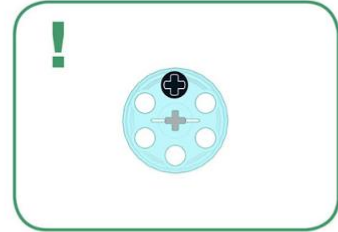

15

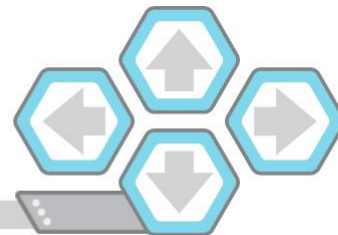
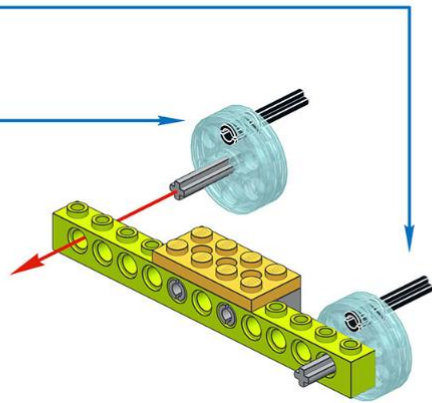



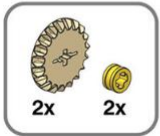

16

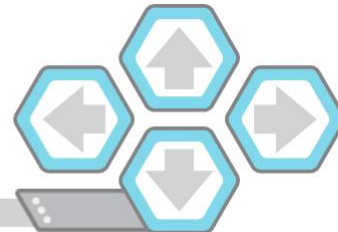
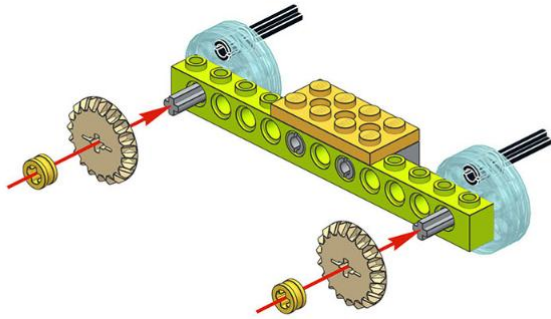

17

sanfrancisco.schul.es

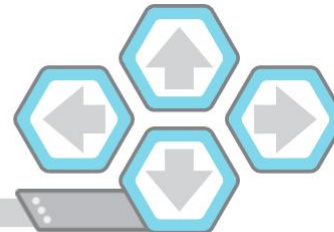
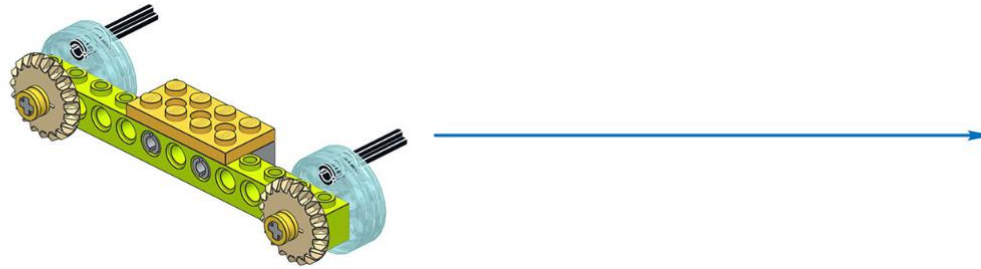

18

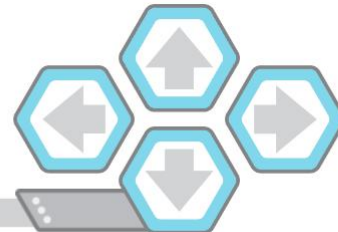
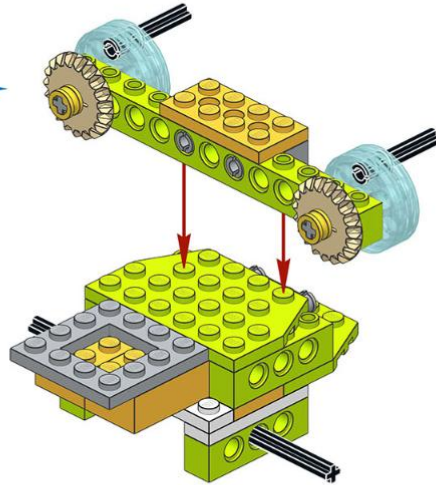

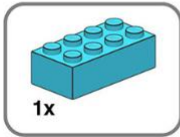

**19**

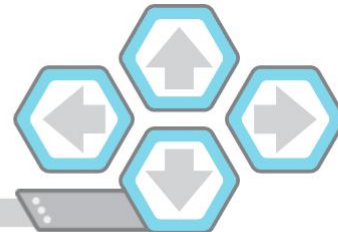
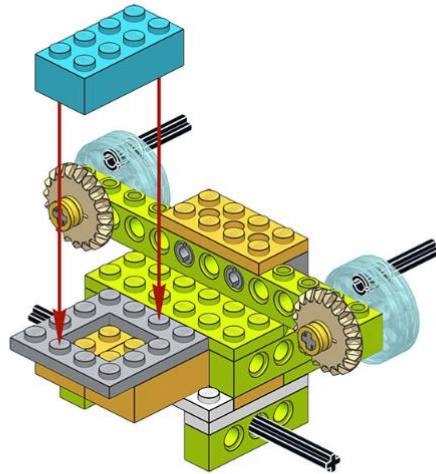

20

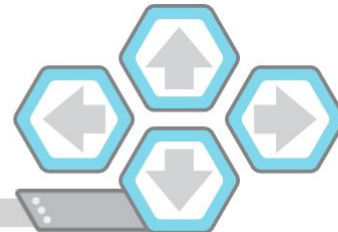
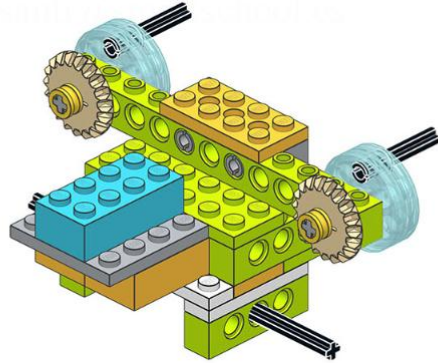

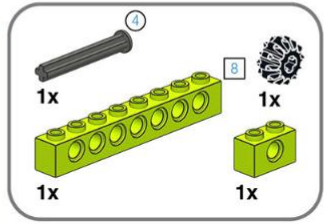
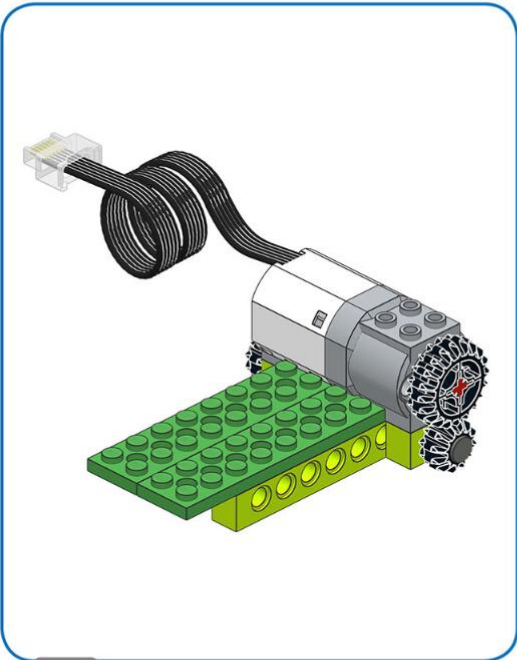

**21**

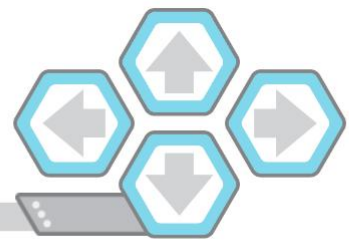
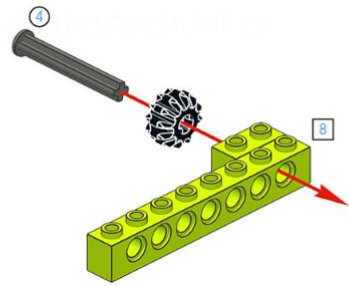

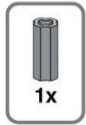

**22**

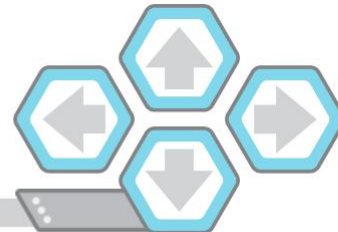
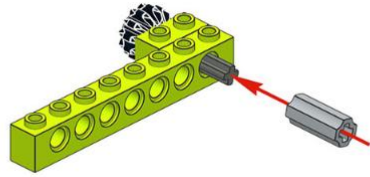

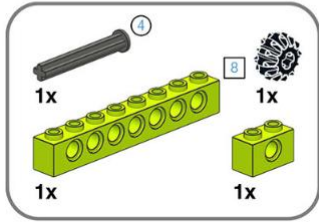

**23**

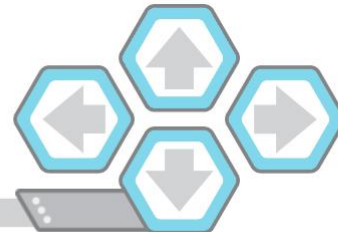
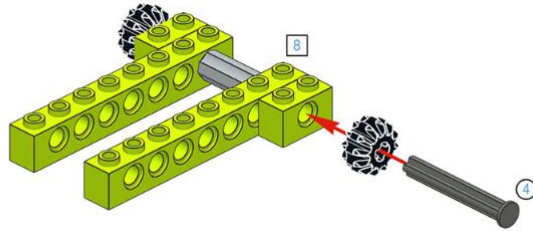



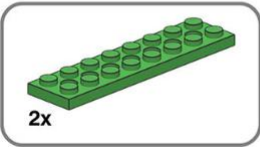

**24**

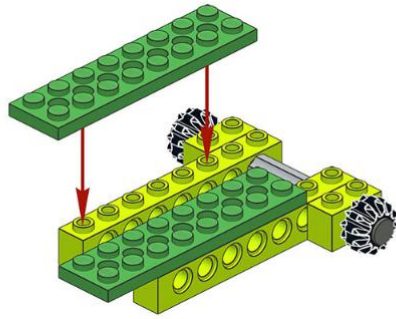

and 2 smart wheels

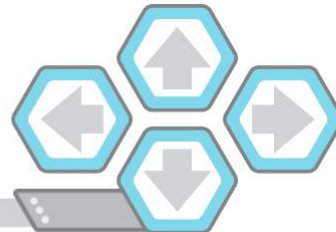

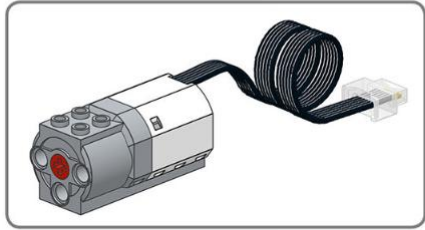

**25**

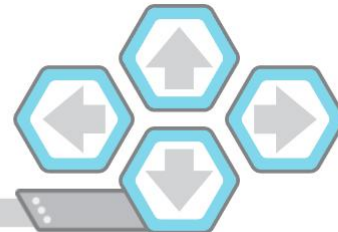
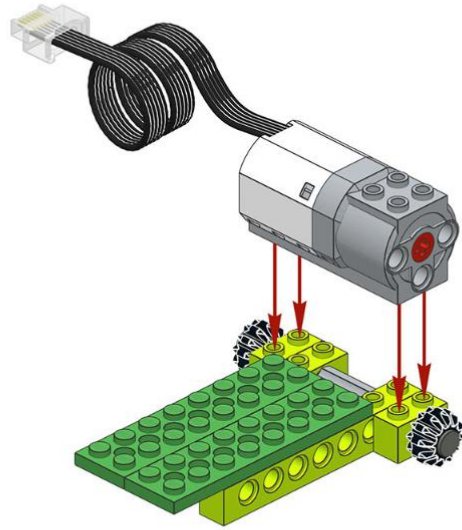

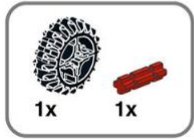

**26**

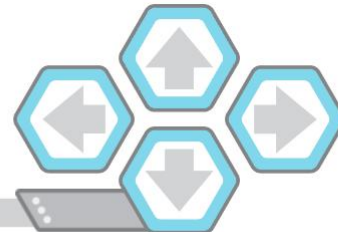
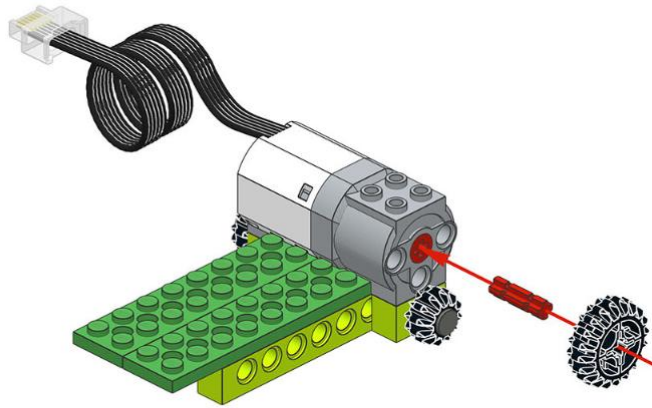

27

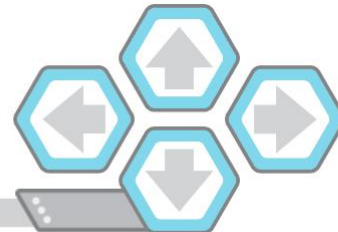
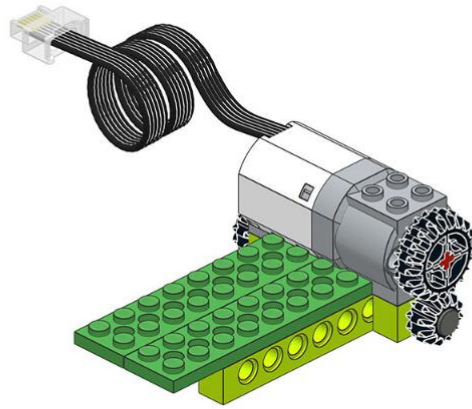

28

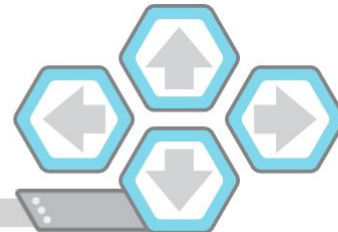
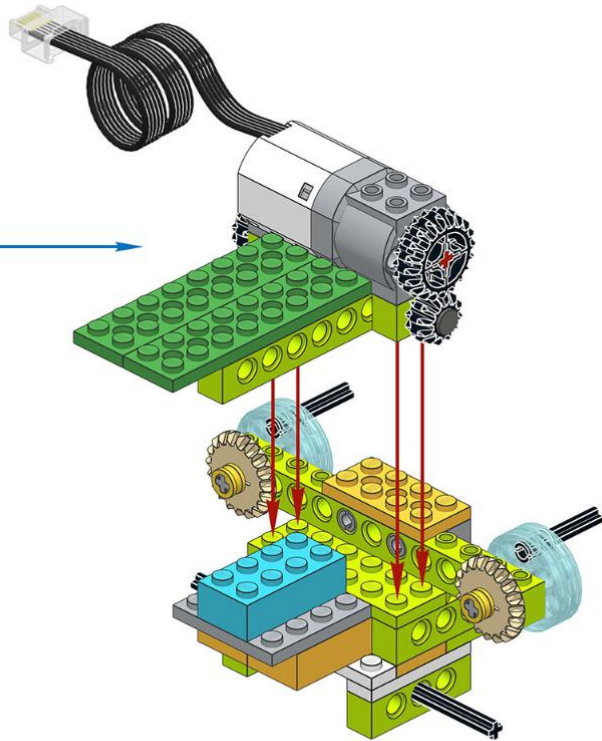

29

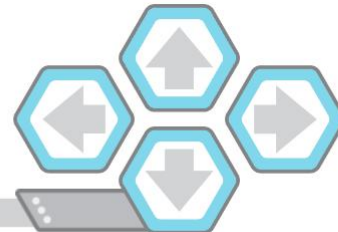
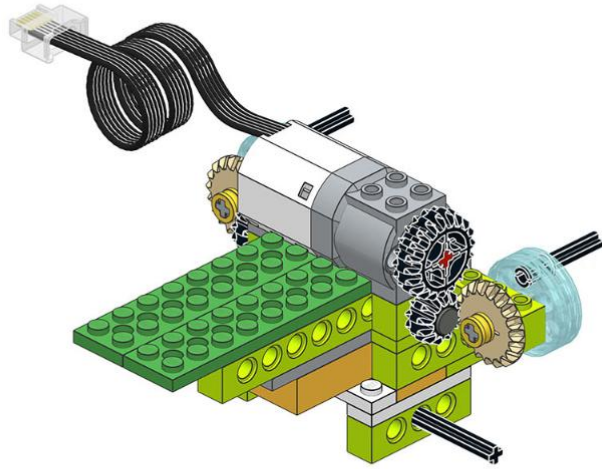

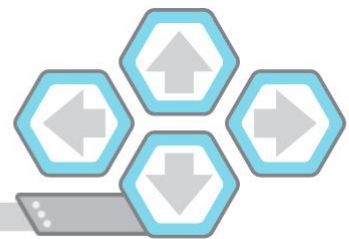
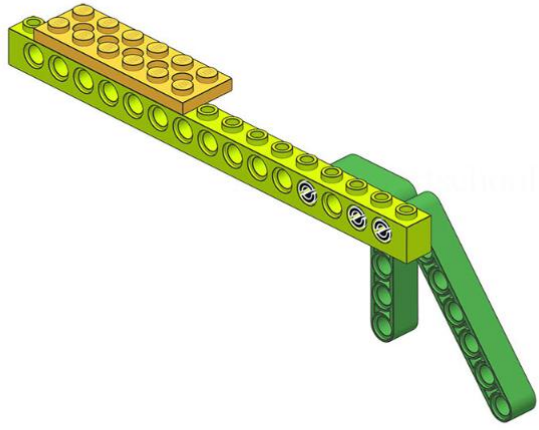



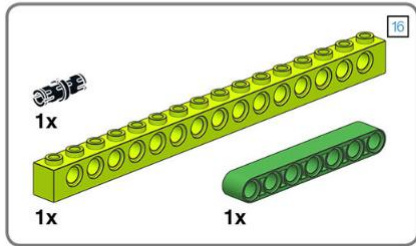

**31**

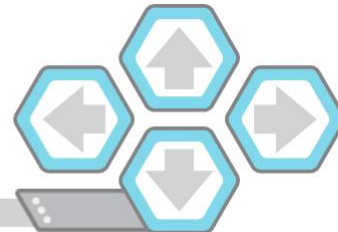
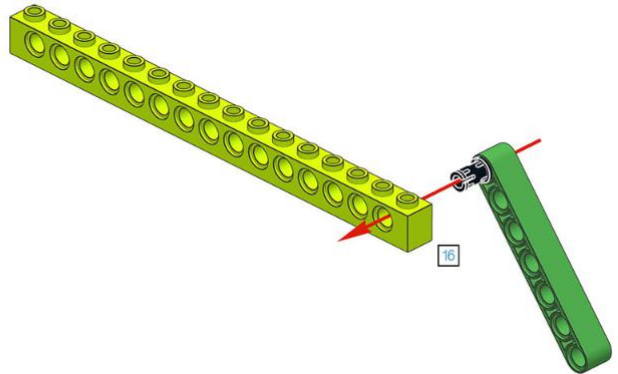



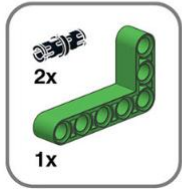

**32**

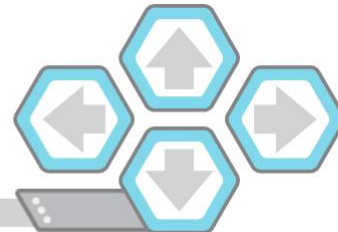
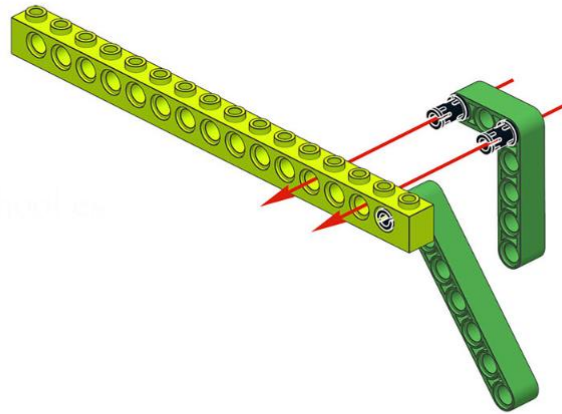

www.esnailschool.es

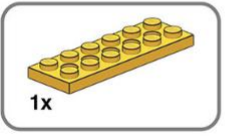

**33**

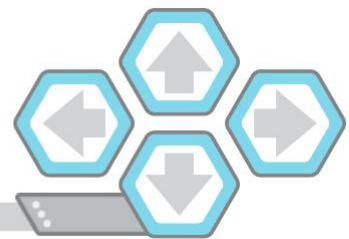
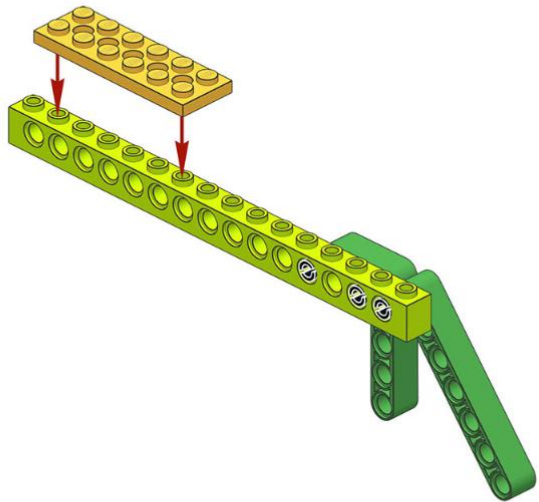

# 34

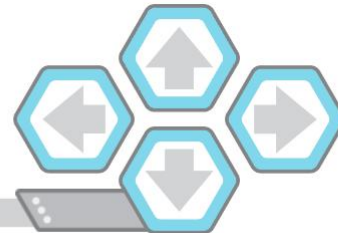
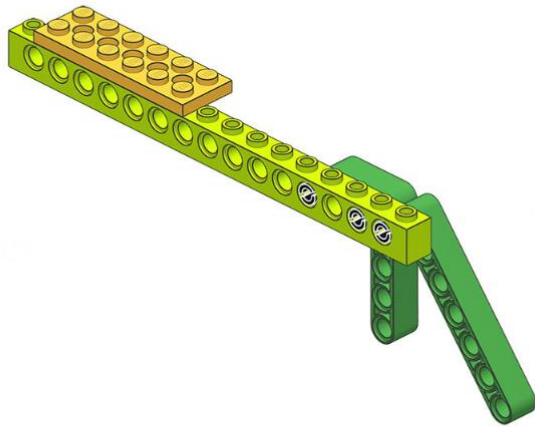

35

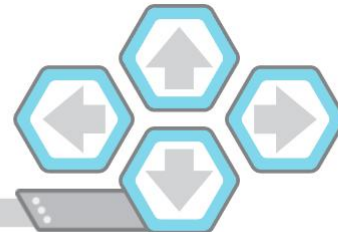
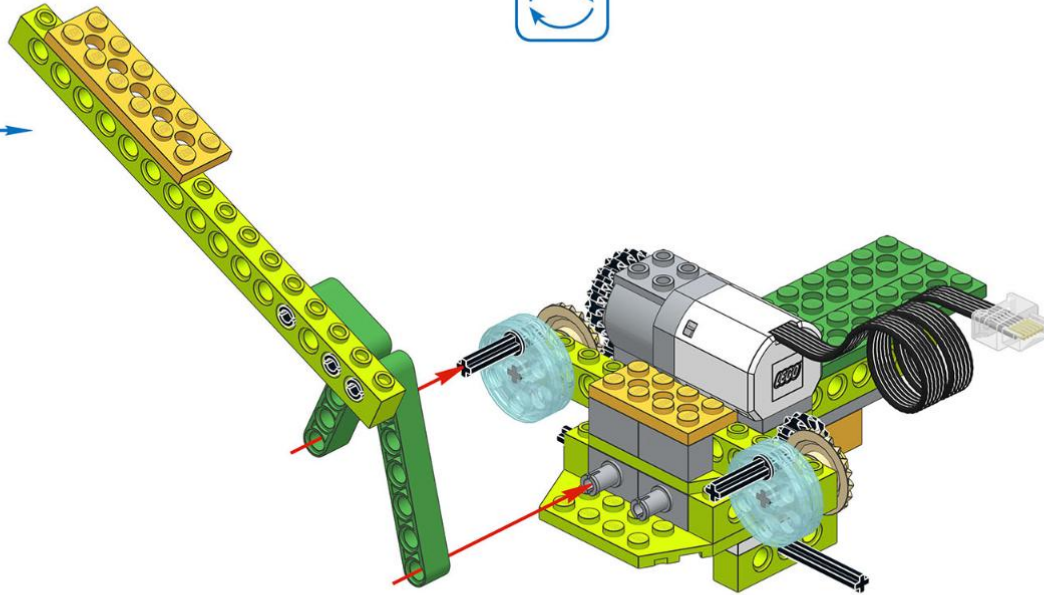

36

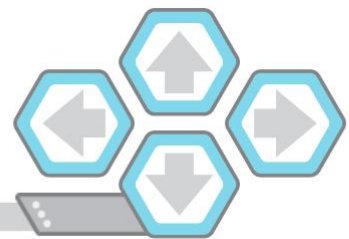
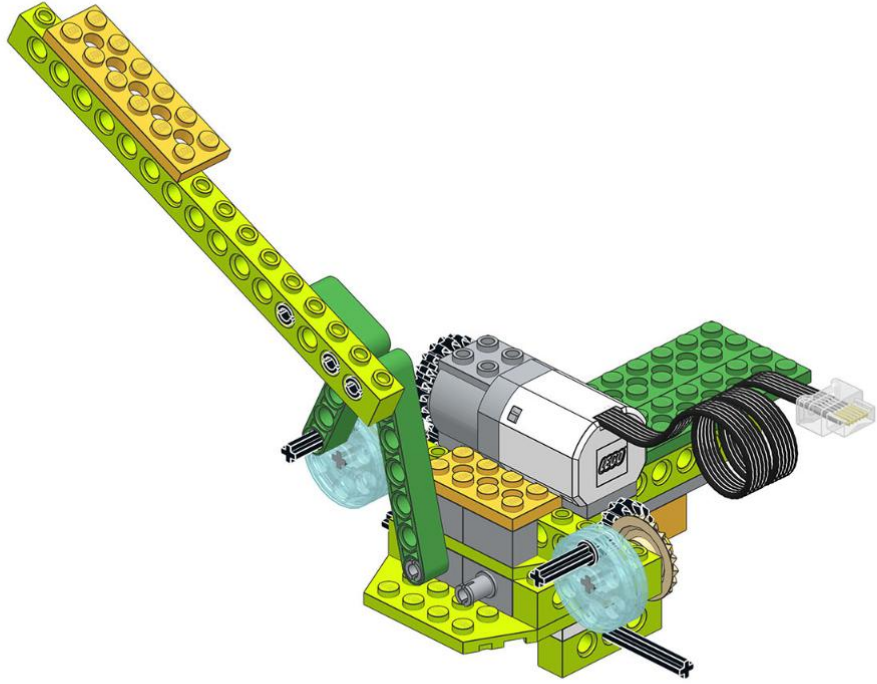



www.smart-school.es

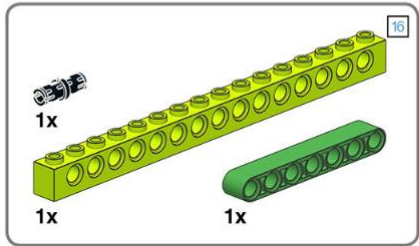

**38**

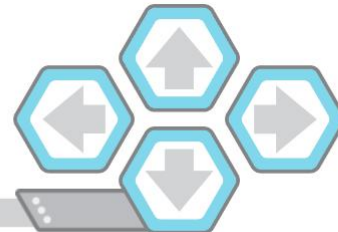
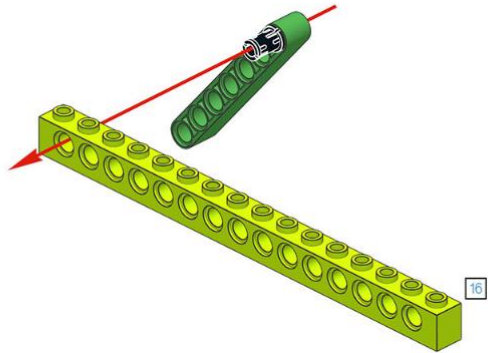

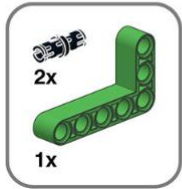

**39**

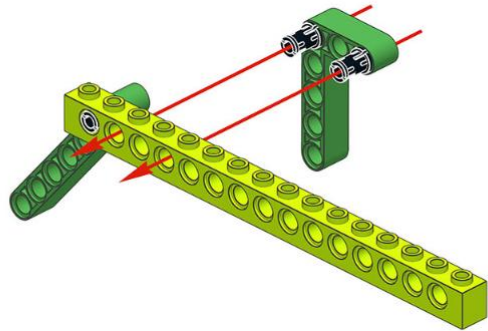

www.roborise.com

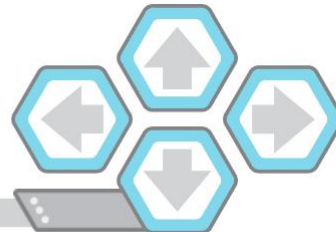



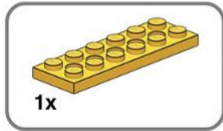

**40**

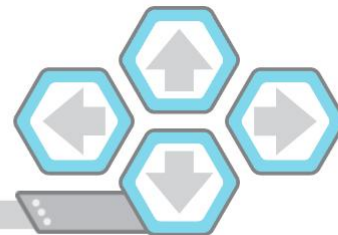
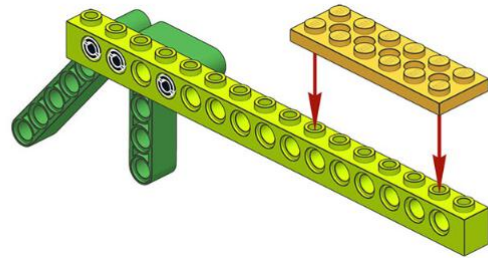

Smart Science

41

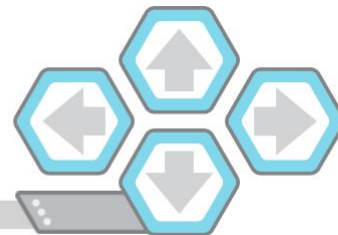
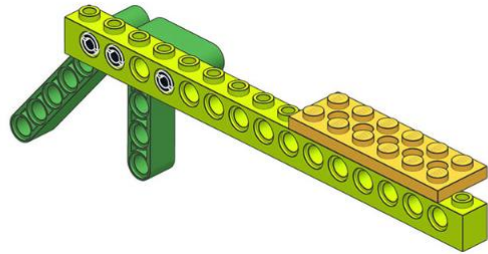

42

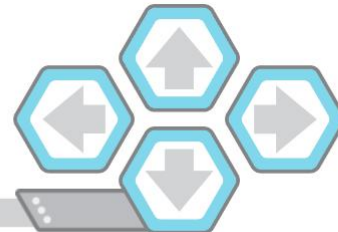
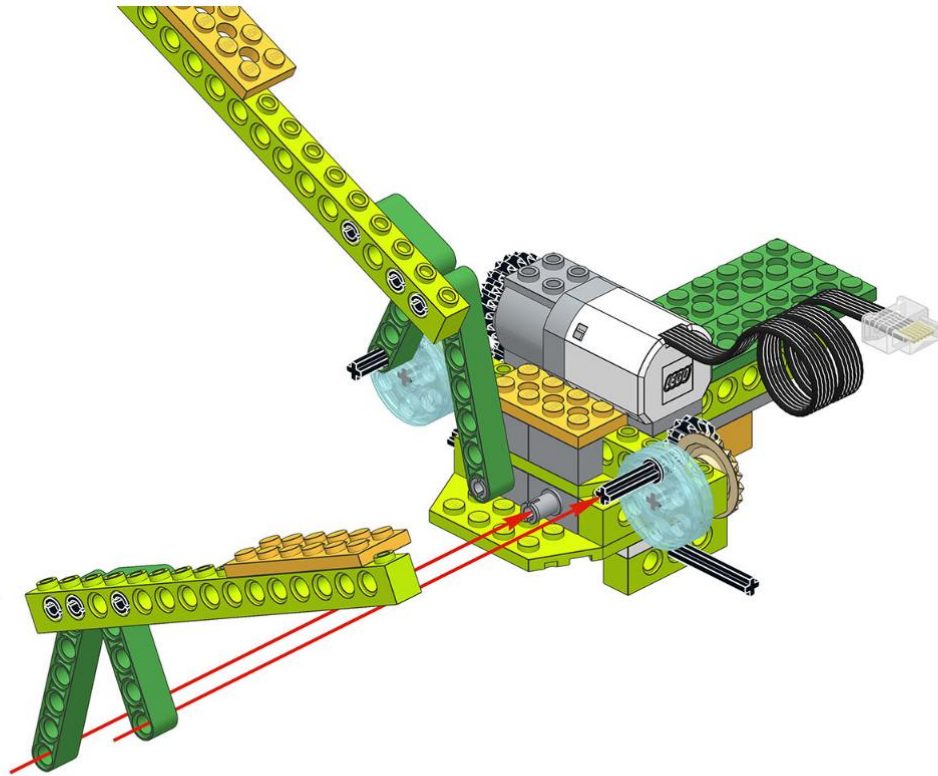

43

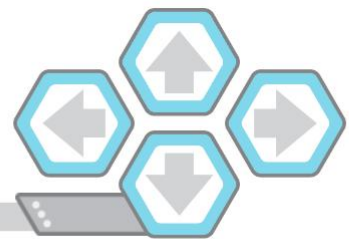
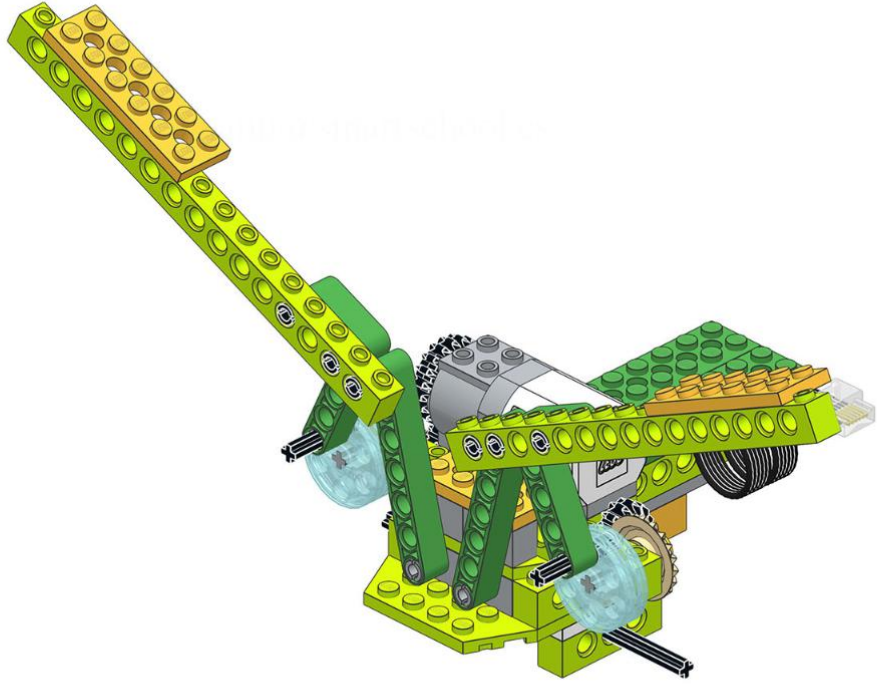

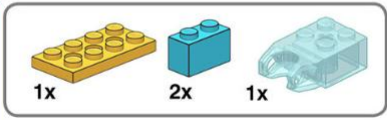

**1**

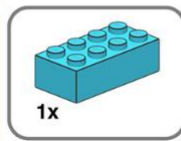
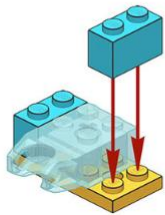

**2**

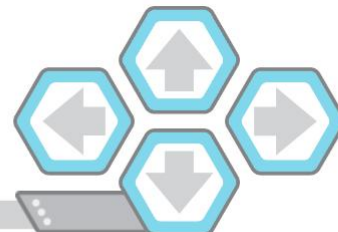
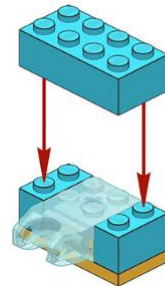

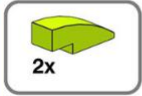

**3**

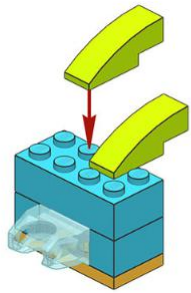

**4**

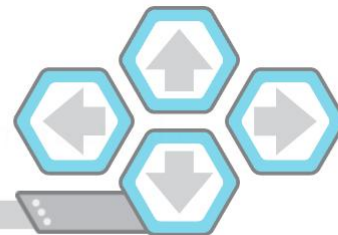
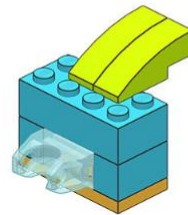

46

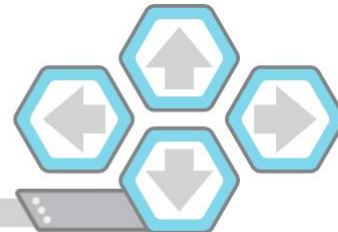
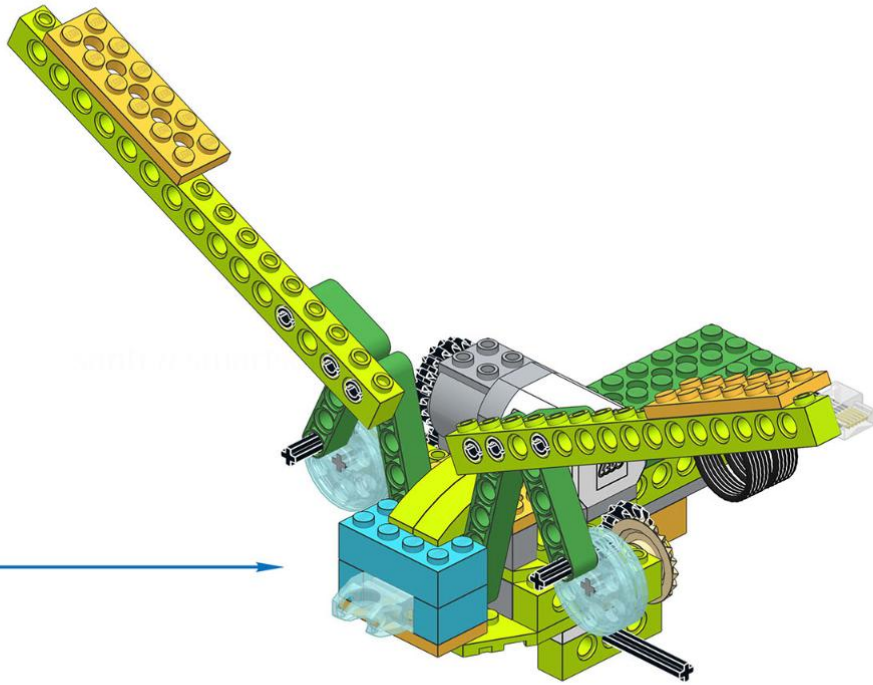



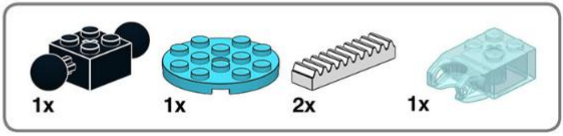
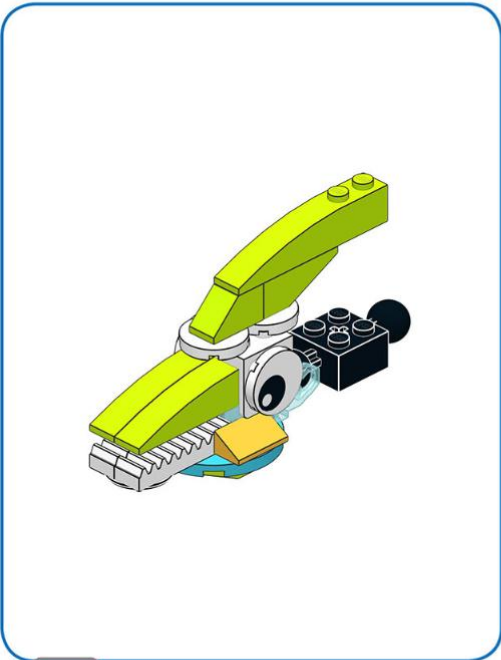

**47**

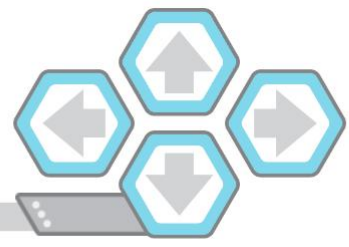
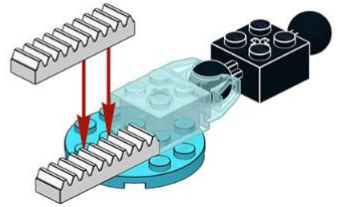





**48**

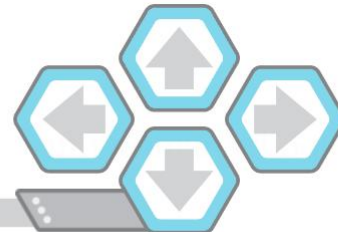
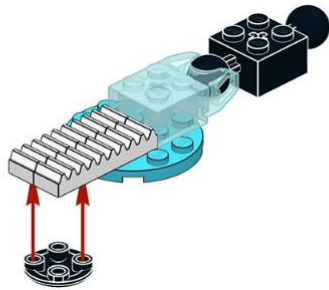

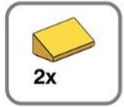

**49**

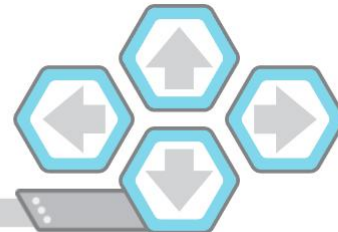
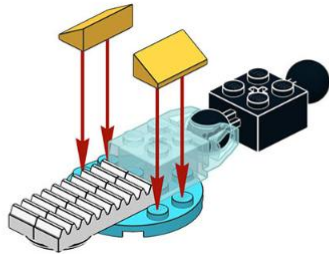

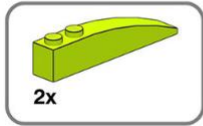

**50**

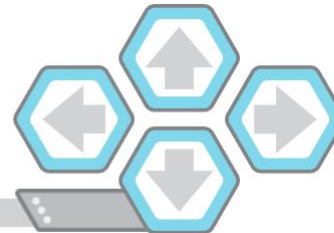
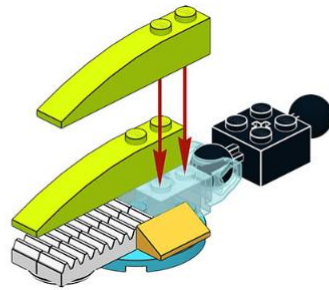

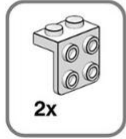

**51**

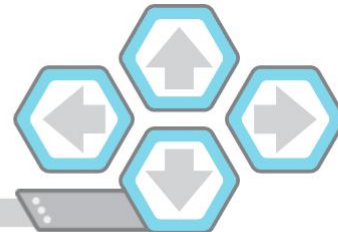
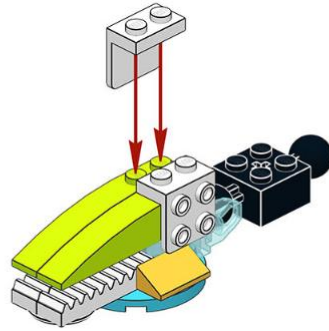

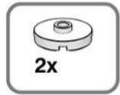

**52**

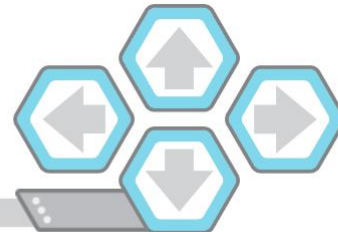
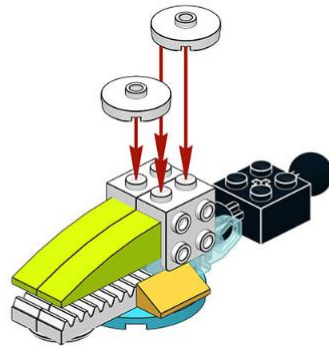

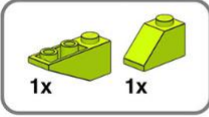

**53**

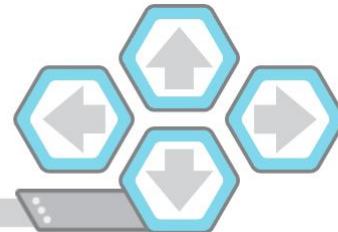
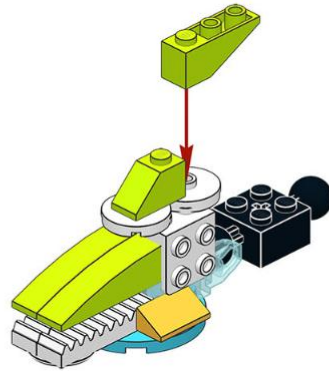

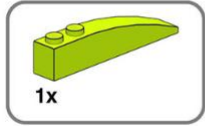

**54**

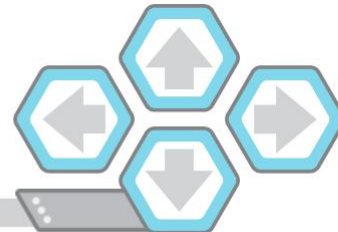
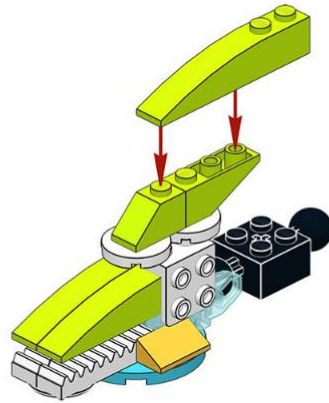

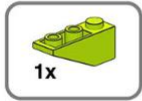

**55**

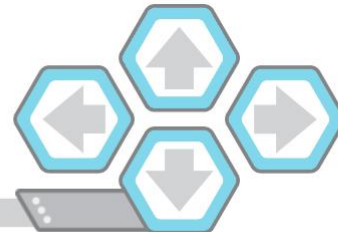
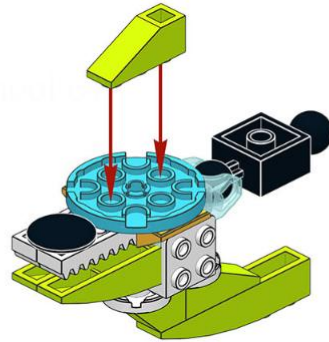



part 2: marshall@es

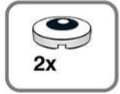

**56**

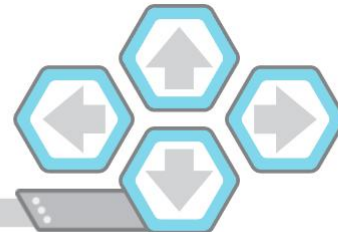
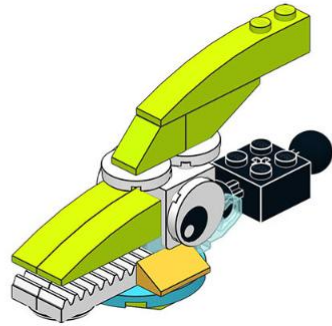

57

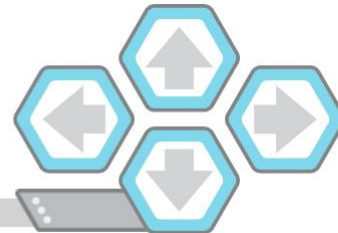
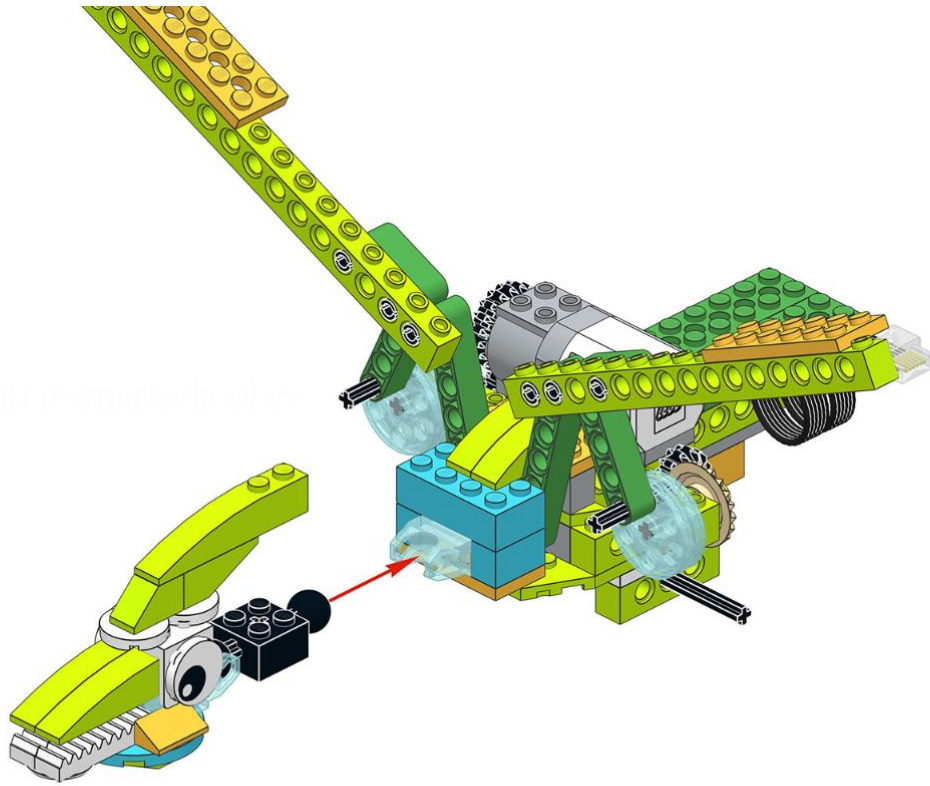



www.roborise.it

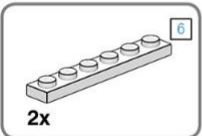

**59**

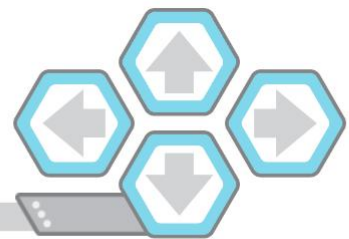
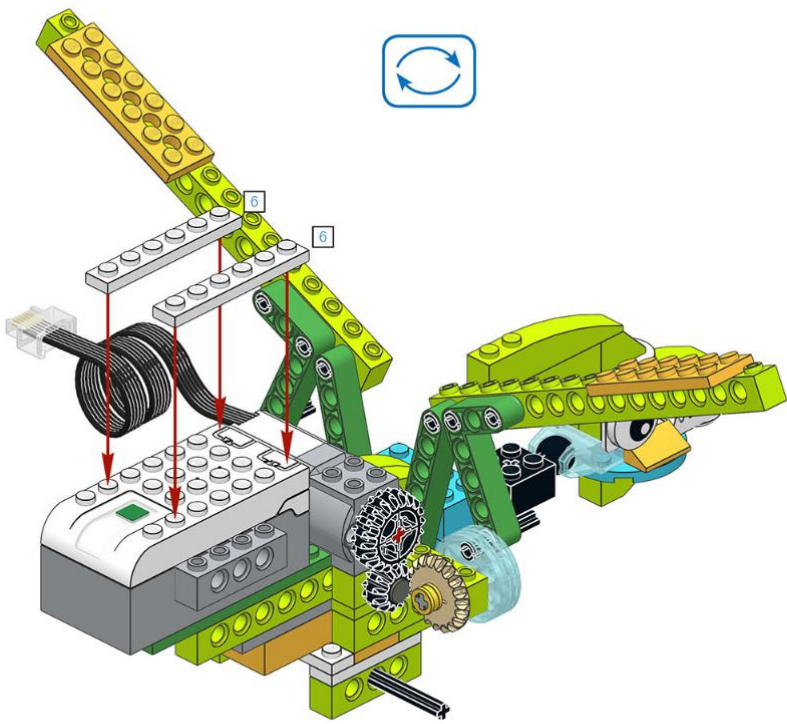

60

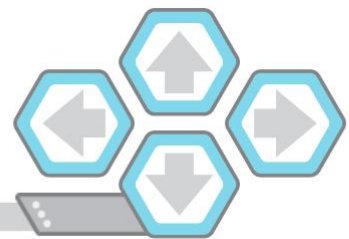
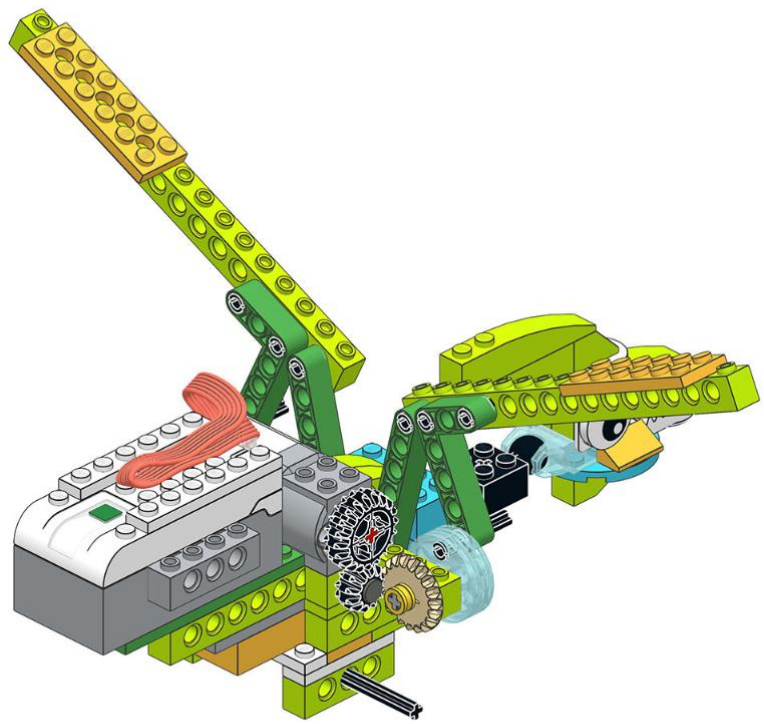



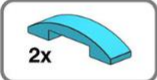

**61**

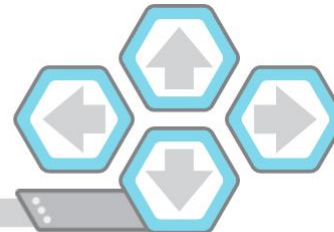
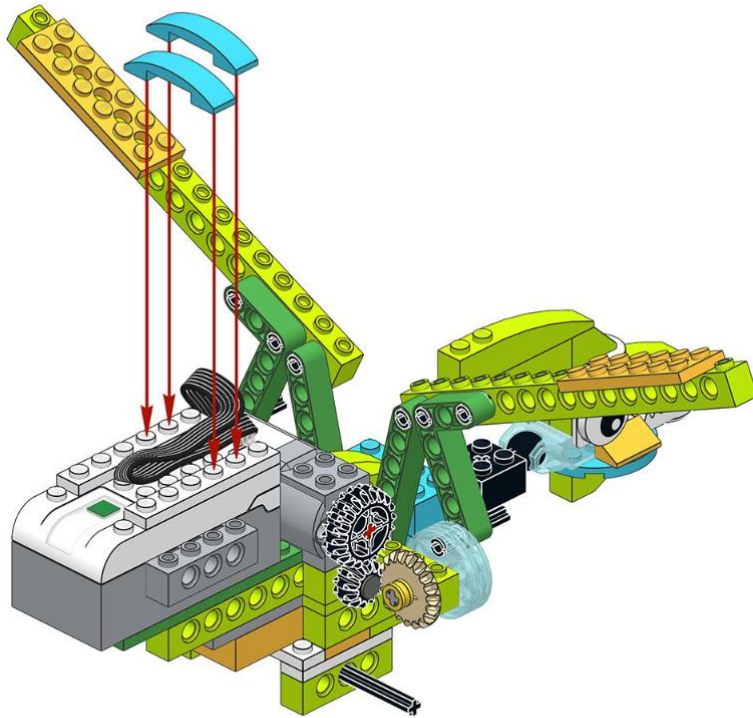

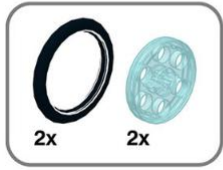

62

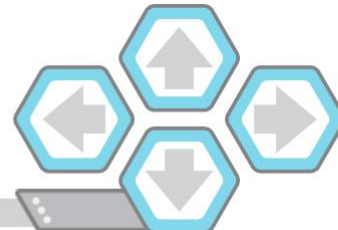
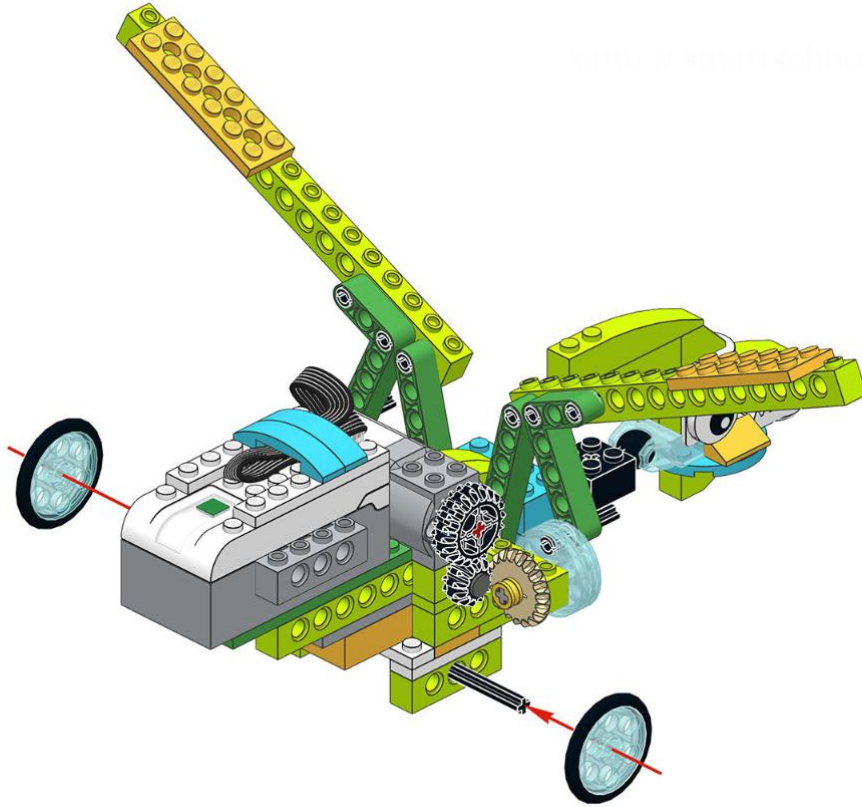

1x 1x 1x

1

2

2x

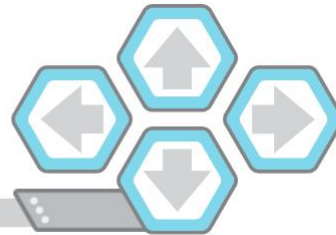
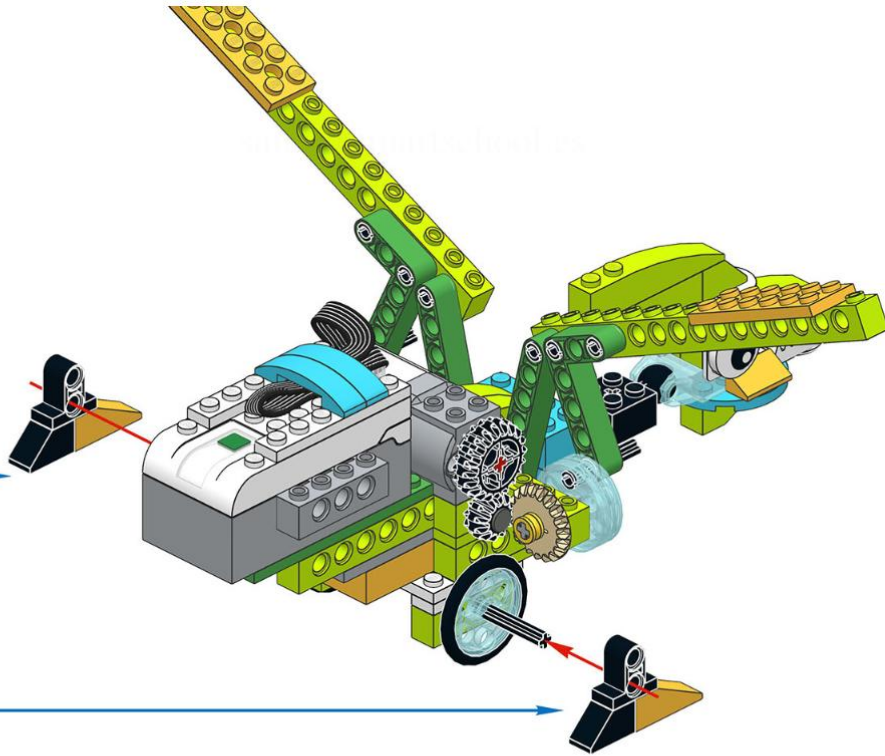



64

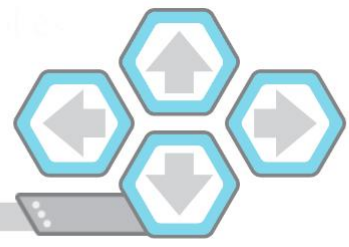
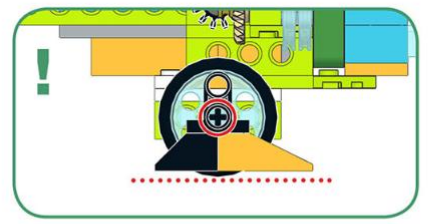
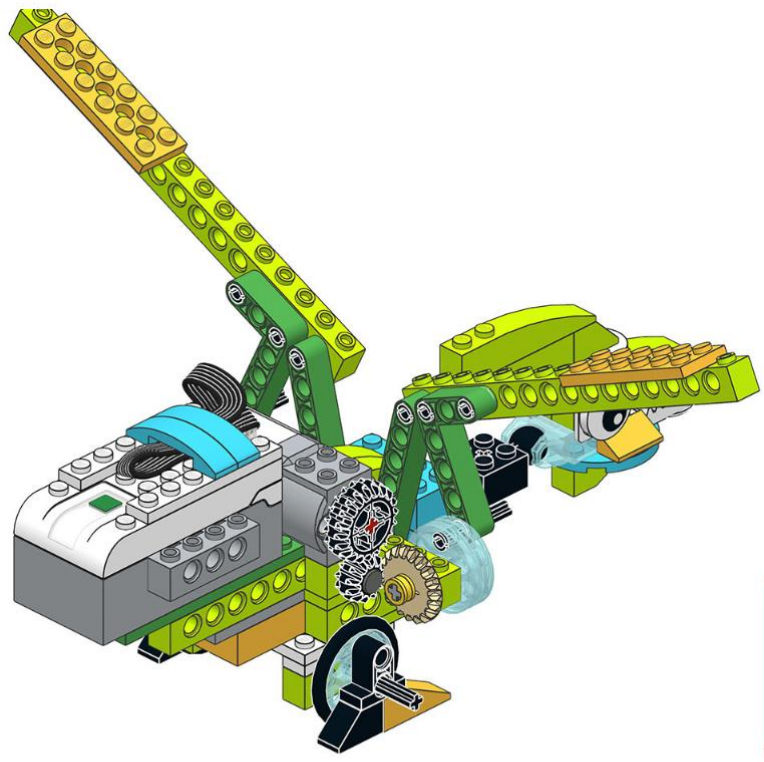



65

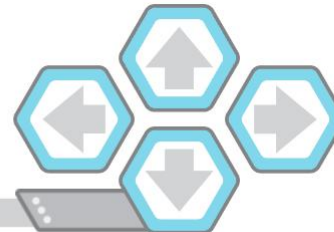
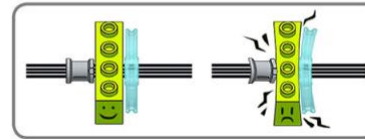
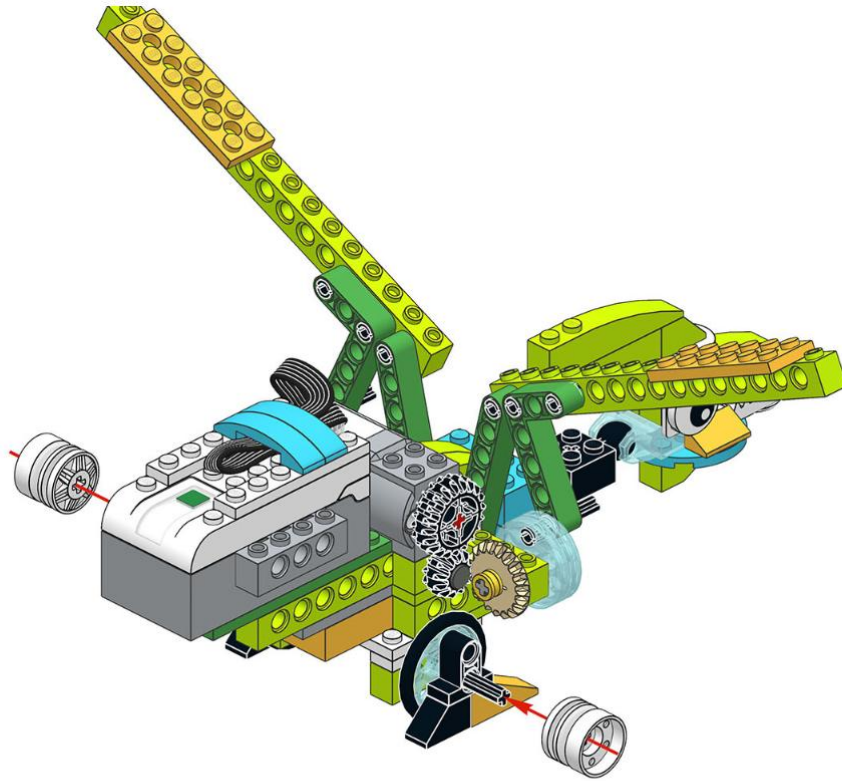

66

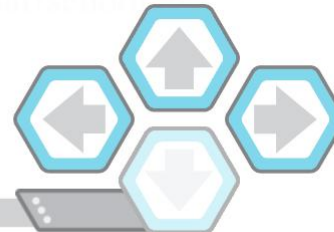
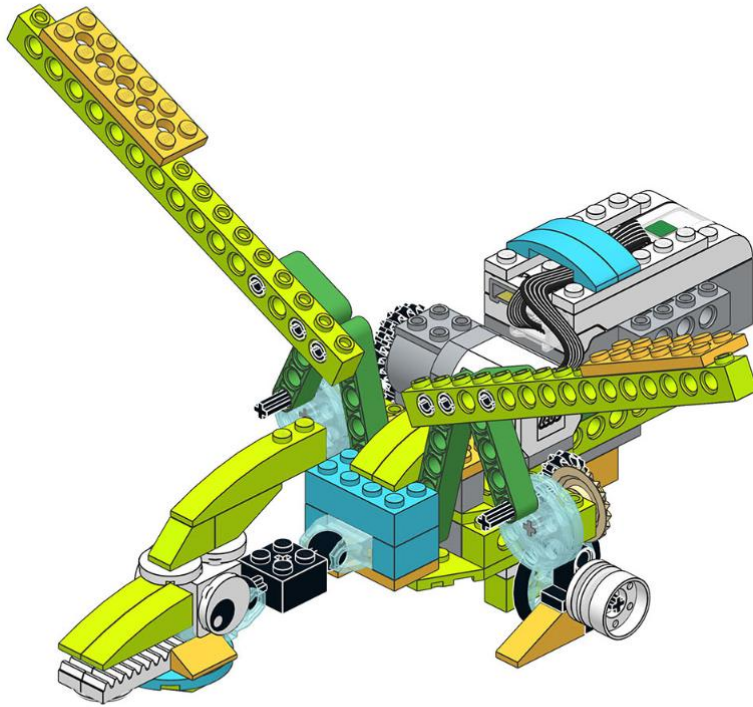

# ⚠ Check it out!

Avoid any friction between the cables while robot is moving.

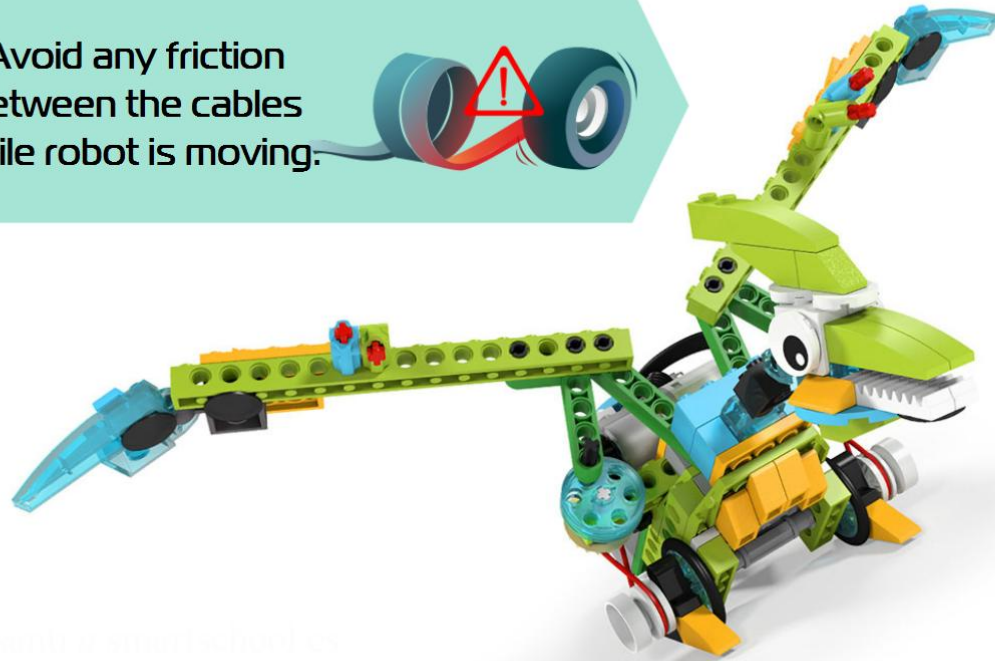

7



94

